

Two-stage Stochastic Programming Based on the Accelerated Benders Decomposition for Designing a Power Network Design under Uncertainty

Ali Akbar Hasani

Ali Akbar Hasani, *Industrial Engineering and Management School, Shahrood University of Technology*

KEYWORDS

Power supply network,
Two-stage stochastic programming,
Preventive maintenance,
Accelerated benders decomposition,
K-means clustering.

ABSTRACT

In this paper, a comprehensive mathematical model of designing an electric power supply chain network via considering preventive maintenance under risk of network failures is proposed. The risk of capacity disruption of the distribution network is handled via using a two-stage stochastic programming as a framework for modeling the optimization problem. An applied method of planning for the network design and power generation and transmission system via considering failures scenarios, as well as network preventive maintenance schedule, is presented. The aim of the proposed model is to minimize the expected total cost consisting of power plants setup, power generation, and the maintenance activities. The proposed mathematical model is solved by an efficient new accelerated Benders decomposition algorithm. The proposed accelerated Benders decomposition algorithm uses an efficient acceleration mechanism based on the priority method which uses a heuristic algorithm to efficiently cope with computational complexities. A large number of considered scenarios are reduced via a k-means clustering algorithm to decrease the computational effort for solving the proposed two-stage stochastic programming model. The efficiencies of the proposed model and solution algorithm are examined using the data from the Tehran Regional Electric Company. The obtained results indicate that the solutions to the stochastic programming are more robust than the obtained ones provided by a deterministic model.

© 2017 IUST Publication, IJIEPR. Vol. 28, No. 2, All Rights Reserved

1. Introduction

Power production systems, transmission and distribution infrastructure as the most important and yet the most widespread used by human beings have significant impact on economic, social, and industrial developments as well as security issues [1]. Therefore, protection of these

key infrastructures against an accidental damage and deliberate disturbance has always been of interest to numerous researchers [1]. For example, power supply systems can be disrupted by a variety of reasons such as weather climate, environmental conditions, equipment failure, human error, and lack of balance between supply and demand sides [2]. Widespread blackouts in Europe in 2006 for 2 hours and power outages for more than fifteen million subscribers are examples of the vulnerability of the electricity

* Corresponding author: *Ali Akbar Hasani*

Email: aa.hasani@shahroodut.ac.ir

Received 7 June 2017; revised 1 July 2017; accepted 15 July 2017

transmission system, which indicates the severity and scope of its impact [3-5]. Blackouts in the north-western States of America in July and August 1996 and widespread blackout in August 2003 for 4 days in different parts of the east coast of America along with many damaging effects on other infrastructures are other examples of disruption of electricity distributing system [1]. Considering the importance of stability and power supply systems, the analysis of the vulnerability of these systems is crucial for researchers [6]. Main Focus of the research conducted on the vulnerability of power transmission systems is on the configuration of power grids and communication of them. For instance, researchers have proposed the concept of entropy electrical current to assess the overall heterogeneity of distribution of load on the network, and they have demonstrated that the entropy power is very dependent on consecutive failures by using the results of the various simulations on the electricity transmission network [7]. The other researchers have proposed an indicator, called total ability, to assess the performance and stability of the power grid under shutdown of a power transmission path [8]. In another research, the power network configuration is studied and its ability to transfer electricity between nodes in the event of disruption of supply and demand in a particular node is determined [9]. Researchers have evaluated the performance of the power transmission system according to the network structure, and they have proposed a systematic approach to measuring the effect of correlated failures on the reliability of the network [10]. This mentioned approach is presented in terms of the probability of satisfying demand by considering constraints of production system such as supply capacity limitation. In another study, a new model aimed at maximizing profit network capacity allocation and terms of the allocation of capacity and performance is provided for the free-scale networks and structures belonging to the North American power grid [11]. In this model, only the supply node is considered, and it is assumed that power generation facilities (power plants) are always available. In addition, the impacts of failures on the reliability and risk assessment of complex infrastructure, such as power grids, have been investigated [12]. In another study, researchers have investigated the reliability of the power grid of America [9]. In this network, the power plants and high-voltage transmission substations are

considered and the main focus is on the network configuration without considering power generation capacity as well as supply and demand limitation. Most of the studies of analyzing the impacts of failures are concentrated on the power network configuration. In the literature of the power network design, a greatly organized approach is not provided for modeling production and transmission systems with regard to important limitations such as capacity, maintenance, and accessibility of network facilities and capacity of substations under various scenarios. Therefore, most of the conducted studies did not consider numerous properties of the power network in real-world context. Although many studies have been done on modeling power production systems in the literature, in general, less attention has been paid to considering power transmission systems. Researchers have examined some of the difficulties associated with modeling decision-making and power generation systems simultaneously including minimizing the cost of managing power generation facilities with regard to production capacity and received demand [13]. In another study, a mathematical model for power plants selection is proposed via considering electricity demand and production capacity [14]. In other study, power generation systems have been studied and the deterministic models for power generation scheduling with the aim of total cost minimization have been proposed [15, 16]. In all of the mentioned studies, the main focus was on the power generation planning without considering the inherent limitations of transfer system such as failure occurrence in system facilities. Only in one study, researchers have proposed a robust scenario-based mathematical optimization model for power transfer planning via considering facilities maintenance under emergency breakdown [17]. Few numbers of scenarios are considered in the mentioned study and the proposed model is solved by optimization solver [17]. As a consequence of that, the power grid is designed as an integrated system of generation and transmission systems, each of these systems will affect the decisions of other systems. Therefore, in this study, a comprehensive planning method for integrated power generation and transfer systems is proposed for power network design under stochastic failures of network facilities. The impacts of these failures on the capacities of network facilities are considered. Each scenario with determined probability occurrence

represents the impact of failure occurrence, and a large number of scenarios are considered to increase an efficiency of the proposed planning method.

The concept of the supply chain network with considering the preventive maintenance could be valuable to examine the integrated network of power generation as well as transfer. The power distribution network is a vulnerable infrastructure and failures occurrences, as well as the need to preventive maintenance, are inevitable. To address the aforementioned issues, a stochastic programming model for the investigation of various failure scenarios, including possible failures of transmission lines and electrical substations, has been presented in this paper. The aim of the proposed model is to minimize the total cost of power generation and distribution network during the planning periods. The proposed stochastic programming model is applied for the designing the network of the Tehran Regional Electric Company as a part of the Iran's electricity grid. The rest of this paper is structured as follows:

In Section 2, the research problem is introduced. Then, the developed mathematical model for the power network design problem is presented. In Section 3, the proposed solution algorithm based on the accelerated Benders decomposition algorithm is described. In Sections 4 and 5, the case study and computational study are presented, respectively. Finally, the paper is concluded in Section 6.

2. Power Network Design Under Uncertainty and Preventive Maintenance

2-1. Problem description

The main purpose of the production and distribution network is to fulfill customer demand in a sustainable manner. Meanwhile, attention to some issues that are more important for the power network planners include limitations associated with power generation capacity of network facilities and possible failure of distribution system from the supply to demand sides. The main problem that has been studied in this paper is how to plan and design a power network in a way that efficiently fulfills the limits of production and distribution in a multi-level power network and considering the preventive maintenance activities, especially in dealing with system failures. Different features of the power network facilities are considered with respect to capacity, setup time, maintenance requirements, and efficiency status. For instance, the

hydroelectric power plant has less setup cost and more limited production capacity than a gas turbine power plant. Planning and implementation of the preventive maintenance have significant impact on reducing the risk of sudden failures and breakdown in power plants. In power production and distribution networks, failure can occur in the production facilities, transmission lines, and electrical substations. The occurrence of any of these types of failures could decrease the power supply capacity, thus, the quality of responsiveness to customers' demands. The occurrence of failures and the subsequent disruptions in the power network is identified by defining specific scenarios that each scenario has a determined probability of occurrence. Therefore, an appropriate and sustainable design for power production and distribution network is required via considering planning for preventive maintenance of facilities under random failures. Finally, the objective of the proposed model is to minimize the total costs of facilities establishment, power generation, and facilities maintenance. The structure of the studied power network is depicted in Figure 1 which represents the four-level network including power plants, substations, transmission lines, and demand points. Considering the power network in the form of a supply chain network not only facilitates the flow of electricity within the network, but also provides the possibility of considering a set of power generation limitations such as generation capacity and maintenance schedule. Furthermore, addressing this problem from the perspective of supply chain management could provide the potential of broad implications and developments such as management of environmental impacts, sustainable development of power grid management, centralized network configuration, the reliability of the integrated power network, risk management, and ultimately the considering the level of customer service. Figure 2 represents the power transmission lines of Iran including 400 KV substations. There is a forward direct flow of electricity through four levels of the power network. In the second and third levels of the considered network, which represent the low- and high- voltage electrical substations, there are various linkages between substations within each network level. Finally, in this paper, a comprehensive mathematical model is proposed for multi-period power generation and distribution network design via considering preventive maintenance planning. The uncertainty of failure occurs and its impact on the

performance of the integrated power network is handled via using scenario-based stochastic optimization.

2-2. Mathematical model

In this section, the proposed multi-period scenario-based mathematical model for integrated power network design via considering preventive maintenance planning is introduced.

2-2-1. Indices

$I, J, K,$ and L : Sets of power plants, high-voltage substations, low-voltage substations, and demand points, respectively,

T and S : Sets of time periods and scenarios, respectively.

2-2-2. Parameters

$g_{i,\min}$ and $g_{i,\max}$: Upper and lower bounds of power generation at power plant i ,

mn_i : Number of required preventive maintenance of power plant i ,

u_j^s and u_k^s : Upper bounds of the capacity of substations j and k under scenario s ,

d_{lt} : Power demand at point l in period t ,

cm_i , cs_i , and cg_i : Cost of power plant maintenance, establishment, and power generation of power plant i , respectively,

τ and P^s : Cost of capacity shortage and probability of scenario s 's occurrence.

2-2-3. Variables

o_{it} : 1 if power plant i is established; 0 otherwise,

m_{it} : 1 if preventive maintenance is done at power plant i ; 0 otherwise,

g_{it} : the amount of power generation at power plant i ,

x_{ijt}^s : Power flow between power plant i and high-voltage substation j ,

y_{ikt}^s : Power flow between power plant i and low-voltage substation k ,

z_{jkt}^s : Power flow between high-voltage substation j and low-voltage substation k ,

$z_{jj't}^s$: Power flow between two high-voltage substations j and j' ,

w_{jlt}^s : Power flow between high-voltage substation j and demand point l ,

v_{klt}^s : Power flow between low-voltage substation k and demand point l ,

$v_{kk't}^s$: power flow between two low-voltage substations k and k' ,

β_{kt}^s and β_{jt}^s : Capacity shortage at low-voltage substation k and high-voltage substation j , respectively.

The schematic overview of the proposed power network is depicted in Figure 3.

2-2-4. Constraints

The proposed model in this study is a two-stage stochastic mixed integer programming. The

decision variables are divided into two groups that include first-stage variables-and second stage variables. The values of variables of the first group are independent of the uncertain scenarios. Therefore, the values of the first stage variables are determined before realization of uncertainty of the stochastic variables. These variables are related to those of power plant establishment, preventive maintenance plan, and the amount of power generation in the first planning period. The other variables are related to tactical and operational decisions affected by uncertainty occurrence and are assigned to the second stage. In other words, after making a decision about the first stage variables, the uncertainty is realized which has significant impact on the second stage variables. For instance, after the realization of the uncertainty of the capacity of substations, the flow assignment between substations of the power network is determined to efficiently respond to customers' demands based on the decision conducted in the first stage. Constraints (1)-(10) present the proposed integrated power network design problem. Each of the power plants in the proposed network has determined upper and lower bounds of power generation capacity (see constraints 1 and 2).

$$g_{i,\min} \times o_{it} \leq g_{it} \quad \forall i, t \quad (1)$$

$$g_{it} \leq g_{i,\max} \times o_{it} \quad \forall i, t \quad (2)$$

All of the generated power in the power plants could not be stored and should be transferred to facilities of the second and the third level of the power network. In the proposed model, the power waste during the distribution process is not regarded (see constraint 3).

$$g_{it} = \sum_j x_{ijt}^s + \sum_k y_{ikt}^s \quad \forall i, t, s \quad (3)$$

Constraints 4 and 5 ensure that the capacity of each substation is satisfied.

$$\sum_i x_{ijt}^s + \sum_{j', j' \neq j} z_{jj't}^s - \beta_{jt}^s \leq u_j^s \quad \forall i, t, s \quad (4)$$

$$\sum_i y_{ikt}^s + \sum_j z_{jkt}^s - \beta_{kt}^s + \sum_{k', k' \neq k} v_{kk't}^s \leq u_k^s \quad \forall k, t, s \quad (5)$$

Constraints (6) and (7) show the flow equilibrium among the input and output power flow for each substation.

$$\left(\sum_i x_{ijt}^s + \sum_{j', j' \neq j} z_{jj't}^s \right) = \left(\sum_k z_{jkt}^s + \sum_l w_{jlt}^s + \sum_{j', j' \neq j} z_{jj't}^s \right) \quad \forall j, t, s \quad (6)$$

$$\left(\sum_i y_{ikt}^s + \sum_j z_{jkt}^s \right) = \left(\sum_l v_{klt}^s + \sum_{k', k' \neq k} v_{kk't}^s \right) \quad \forall k, t, s \quad (7)$$

Constraint (8) indicates the response to customers' demand in the fourth level of the power network. The required time period for applying the preventive maintenance is presented by constraints (9). Constraint (10) shows the shutdown status of each power plant demurring the maintenance periods.

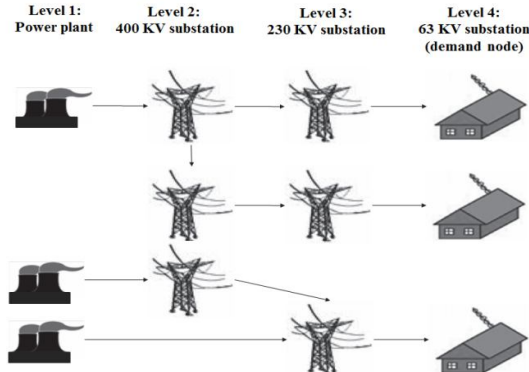

Fig. 1. The four level power network

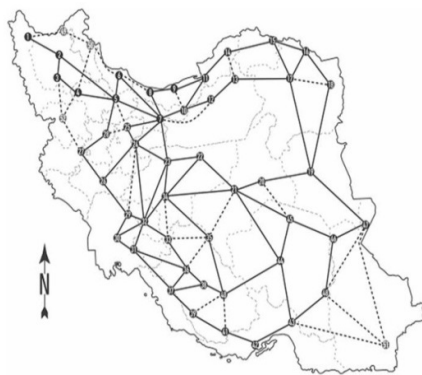

Fig. 2. The network of power substations of Iran power network includes 400 KV transfer lines [17]

The schematic overview of the proposed power network is depicted in Figure 3.

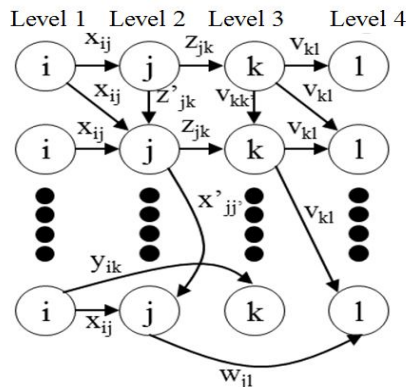

Fig. 3. The schematic overview of the power network related to the proposed mathematical model

$$\sum_k v_{klt}^s + \sum_j w_{jlt}^s \leq d_{it} \quad \forall l, t, s \quad (8)$$

$$\sum_t (1 - m_{it}) = mn_i \quad \forall i \quad (9)$$

$$o_{it} \leq m_{it} \quad \forall i, t \quad (10)$$

2-2-5. Objective function

The objective of the proposed mathematical model is to minimize the total cost of the integrated power generation and distribution simultaneously (see equation 11).

$$\text{Min } Z = \sum_{i,t} cs_i o_{it} + \sum_{i,j \neq 1} cs_{ij} o_{ij} \times (1 - o_{i,t-1}) + \sum_{i,t} cg_i g_{it} + \sum_{i,t} cm_i (1 - m_{it}) + \sum_s P^s \cdot x \times (\beta_{kt}^s + \beta_{kt}^{rs}) \quad (11)$$

2-2-6. Linearization technique

The nonlinear term of the proposed objective function (equation 11) is linearized via using a linearization technique based on the change in variable technique as follows:

$$S_{it} = \begin{cases} 1 & o_{it} - o_{i,t-1} = 1 \\ 0 & o_{it} - o_{i,t-1} \neq 1 \end{cases} \quad (12)$$

$$S_{it} \geq o_{it} - o_{i,t-1} \quad (13)$$

3. Solution Algorithm Based on The Accelerated Benders Decomposition Method

The proposed model is a scenario-based stochastic mixed integer programming model. As a consequence of considering various practical features of the power network design problem in this study, the proposed model is so complex and involves various decision variables and constraints. While, in general, the network design problems are NP-hard [18-20]. The information about the number of the decision variables and constraints as functions of the proposed problem size in the proposed model is presented in Table 1. The obtained results indicate that by increasing the size of the power network, the number of decision variables, especially binary variables as well as the number of constraints will increase strictly. In addition, the number of decision variables and constraints will increase as a result of an increase in a number of scenarios and planning periods. Therefore, the complexity of problem-solving will significantly intensify by dealing with large-scale power network design problems. The described mathematical model in Section 2.2 can be represented in a general form as follows:

$$\text{min } c_1^T z + c_2^T w + q_1^T x \quad (14)$$

$$z \in Z \subseteq \{0,1\}^{|S_E| \times |S|} \quad (15)$$

$$Rx \leq u \quad (16)$$

$$Hx \leq Mz \quad (17)$$

$$Dx \geq d \quad (18)$$

$$x \in \mathbb{R}_+^{|\mathcal{A}|+|\mathcal{P}|} \quad (19)$$

Tab. 1. Size of the proposed power network design problem

| Dimension | |
|---|----------------------|
| 2. I . T | Binary variables |
| I . T + I . J . T . S + 2. I . K . T . S + J ^2. T . S + J . L . T . S + K . L . T . S + K ^2. T . S | Continuous variables |
| 3. I . T + 2. I . T . S + 2. K . T . S + J . T . S + L . T . S + I | Constraints |

In this study, change in the required data for decision making is considered as the main source of the uncertainty. Therefore, the two-stage scenario-based stochastic programming approach is adopted to solve the proposed problem. The stochastic two-stage objective minimizes the total operational cost of power network after realization of uncertain parameters and making the first stage decisions. The capacity of the facility after failure occurrence is accompanied by uncertainty. Random vector $\bar{\xi} = (\bar{d}, \bar{u}, \bar{q})$ is a realization of uncertain parameters $\xi = (d, u, q)$.

A new variable is added to the left-side of constraint (18) so that the recursive function can still be feasible for all possible combinations of decisions of the first stage. The Value of this variable in the objective function is equal to the penalty of capacity shortage, as a cost of the blackout. The proposed two-stage stochastic programming is as follows:

$$\min_{z,w} f(z,w) = c_1^T z + c_2^T w + E_{\bar{\xi}} [Q(z, \bar{\xi})] \quad (20)$$

$$z \in Z \subseteq \{0,1\}^{|\mathcal{E}| \times |\mathcal{S}|} \quad (21)$$

$$w \in W \subseteq \{0,1\}^{|\mathcal{S}^N|} \quad (22)$$

$$Q(z, \xi) = \min_{x,pr} q^T(\xi)x + h^T \Pr \quad (23)$$

$$Rx \leq u(\xi) \quad (24)$$

$$Nx = 0 \quad (25)$$

$$Hx \leq Mz \quad (26)$$

$$Dx + \Pr \geq d(\xi) \quad (27)$$

Objective function (20) involves the cost of strategic decisions and value of expected costs of operational decisions. $Q(z, \xi)$ is the random function related to first-stage decision z and scenario ξ . In the first-stage of the model, the configuration of the power network is determined (Constraints 20-27). In the second-stage, the decision related to operational decisions, which are affected by the scenario, are conducted.

Interested researchers can be referred to Birge and Louveaux [21] and Ruszczyński and Shapiro [22] for more details on two-stage stochastic programming methods. Finally, the overall steps of the proposed solution algorithm are presented in Figure 4. According to the tests conducted for the issues examined in this paper, the classic Benders decomposition algorithm has a weak convergence because of the existence of a large number of the first repetitions, which are ineffective without significant improvements to the optimal point. Hence, there is a need to improve the efficiency of the classic Benders decomposition. Therefore, in this paper, a simple but effective method is used for generating heuristic basic feasible solution. This approach leads to develop appropriate cuts and ultimately improve convergence in the initial iterations of the Benders decomposition algorithm. For this purpose, the heuristic approach based on the prioritizing allocation technique is adopted which is described as follows [21]. In the first step, a set of random numbers is assigned to the power plant and each node with the highest priority is selected for the allocation of demand according to the allocation cost. End of the allocation task is dependent on achieving the maximum supply capacity as well as satisfying the total demands of customers. In case of using the maximum supply capacity, the next supply node is selected with the highest priority. This process continues to meet the maximum of customers' demands. In the second step, demand node with the highest priority is selected, and it is assigned to the supplying node with the lowest supply cost with the amount of minimum of supply capacity and demand. Then, the priorities of the two nodes become zero and the next node with the highest priority is selected. This process continues to respond to maximum possible demand. At least 20 numbers of feasible solutions are generated without considering the quality of each solution by using the proposed heuristic algorithm. Then, only 10 numbers of the best generated solutions are selected and their related cuts are developed. In the proposed solution algorithm, k-means clustering method is adopted to decrease the scenario numbers. The computational time increases significantly as a consequence of considering the large number of scenarios [22]. In the proposed model, the uncertainty of the decision making environment is considered, although we have tried to reduce the computational difficulties. For this reason, 1000 numbers of scenarios have been generated. Then,

the number of scenarios is reduced to 100 by using the k-means clustering algorithm. In Table 2, the reason for reducing the number of scenarios is presented. The objective gap is equal to the difference of the value of the objective functions of the test problem in comparison with considering the test problem with 1000 numbers of scenarios. As shown in Table 2, by decreasing the scenario number to 50, the objective gap increases, although the solution runtime has been significantly reduced. With considering 50 numbers of scenarios, the objective gap equals 6.27 percent that is a high-error rate due to the strategic nature and longtime effects of supply chain network design decisions.

4. Case study: Tehran Regional Electric Company

Iran has an integrated power grid network consisting of generation, transmission, and distribution systems. This paper focuses on the generation and transmission, which can be regarded in the form of an integrated network. The arcs in the network represent the transmission lines. The Iranian grid network includes 400 and 230 KV transmission lines with a length of more than 30 thousands km and 132 and 63 KV low-voltage transmission lines [23]. Nodes in this network represent the power plants

as a part of the production system and power substations as a part of the transmission system. The 400 KV transmission lines and electrical substations of Iran's electricity grid are shown in Figure 2. In this paper, to solve the proposed mathematical model, only part of the Iran power network which belongs to the Tehran Regional Electric Company is considered. Tehran Regional Electric Company is responsible for satisfying demands of electricity consumers of Tehran, Alborz, and Qom province in Iran (see Figure 5). The covered areas of Tehran Regional Electricity company are very important in terms of economic, industrial, and security perspectives. This emphasizes the importance of planning for sustainable service provided to subscribers in this region.

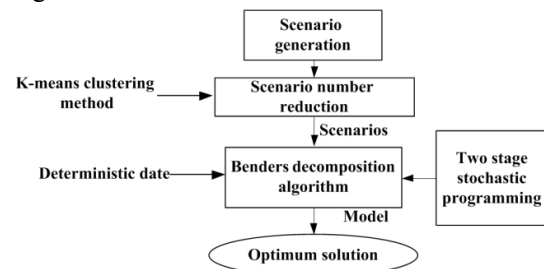

Fig. 4. Steps of the proposed hybrid solution algorithm

Tab. 2. Performance evaluation of the proposed k-means clustering algorithm

| Objective value error (%) | Time improvement (%) | Time (sec.) | Objective value | Scenario number |
|---------------------------|----------------------|-------------|-----------------|-----------------|
| - | - | 2734 | 1.57495 e+12 | 1000 |
| 0.0048 | 7.23 | 2292 | 1.57503 e+12 | 800 |
| 0.0076 | 36.42 | 1880 | 1.57507 e+12 | 600 |
| 0.045 | 59.49 | 1507 | 1.57566 e+12 | 400 |
| 0.215 | 73.21 | 1263 | 1.57834 e+12 | 200 |
| 0.371 | 91.13 | 935 | 1.56913 e+12 | 100 |
| 6.27 | 95.57 | 624 | 1.67370 e+12 | 50 |
| 21.8 | 98.59 | 358 | 1.91877 e+12 | 10 |

Tehran Regional Electric Company has 15 power plants in four different types that include steam turbines, gas turbines, combined cycle, and hydropower. Nominal capacity and power

generation of power plants according to their types are shown in Table 3. Upper and lower limits of the power generation based on the minimum and maximum numbers of generating units are shown in Figure 6 [17]. In Table 4, fuel

and maintenance costs of each type of the power plant are presented [17]. There are high-voltage (400 KV) 14 substations and low-voltage (230 KV) substations in the considered power network. Capacities of high- and low-voltage electrical substations are shown in Figures 7 and 8, respectively. In addition, there are 213 numbers of 63 KV substations in the fourth level of the considered transmission system. Power substations at this level of the transmission system are at the first level of the electricity distribution system. These electrical substations are regarded as demand nodes in the considered generation and transmission system. Usually, in the spring and summer seasons, there is a higher demand for electricity at demand nodes. In this study, power demand is regarded for a period with a six-month duration includes the spring and summer seasons with the aim of considering peak power consumption based on the data of the previous studies [17].

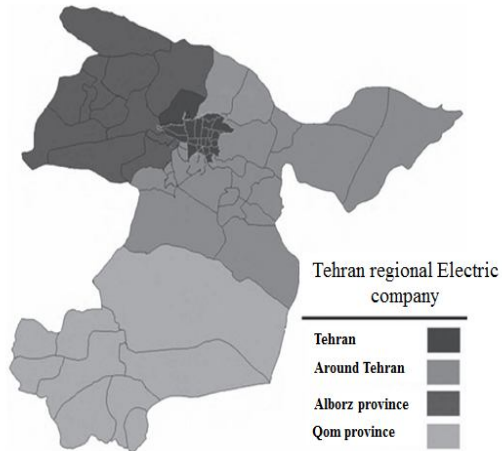

Fig. 5. Covered areas by the Tehran Regional Electric Company

Tab. 3. Nominal capacity and monthly power generation

| Monthly power generation | | Nominal capacity | | Power plants |
|--------------------------|---------|------------------|---------|----------------|
| % | MWh | % | MWh | |
| 21.6 | 1169315 | 26.7 | 2683 | Gas turbine |
| 21.3 | 1152399 | 19.1 | 1922.5 | Steam turbine |
| 55.8 | 3023189 | 51.1 | 5143.4 | Combined cycle |
| 1.3 | 68262 | 3.1 | 316 | Hydropower |
| 100 | 5413165 | 100 | 10138.3 | Total |

The definitions of scenarios for failures of network facilities are based on the experts' opinions and the previous conducted studies

about the Tehran Regional Electric Company [17]. The power grid is always under intentional and unintentional threats. The occurrence of any failure could lead to disruption event in power network performance and then change on the condition of electricity production and maintenance planning. In general, three types of failures that can occur in the power network including random failures in the nodes, intentional failures in the nodes with the highest degree (maximum number of input and output lines), and random failures of the transmission lines between nodes. Therefore, a variety of scenarios of failures occurrence in different network levels can be considered in the power network planning.

5. Computational Results

5-1. Performance evaluation of the proposed benders decomposition

In this section, results of investigating the performance of the proposed Benders decomposition algorithm in terms of solution quality and computational time are presented. Dimensions of the test problems, the optimal value of the objective function and the computational times of applying the Benders decomposition algorithm as well as the GAMS optimization software 24.1.3 are presented in Tables 5 and 6. The obtained results indicate that the Benders decomposition algorithm has improved the computational time of solving the proposed model to the 68.26 percent compared with the solutions obtained by GAMS. In Tables 6 and 7, the performance of the proposed accelerated Benders decomposition algorithm is compared with that of the traditional Benders algorithm. The obtained results show the better convergence of the accelerated Benders algorithm. Table 6 shows that the accelerated Benders algorithm starts the search process with less distance to an optimal point which indicates better performance of the primary cuts. Finally, the total numbers of iterations to reach the final solution are compared in Table 7.

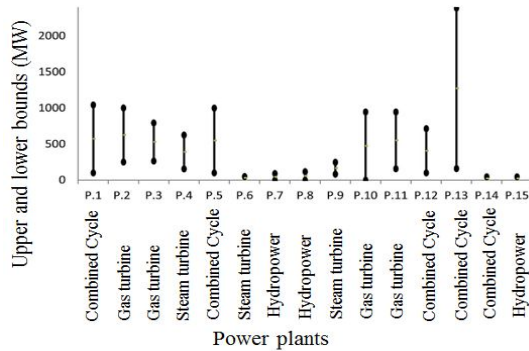

Fig. 6. Limits of power generation capacity of each plant

Tab. 4. Cost of fuel and maintenance by type of power plant

| Fuel cost | Fuel type | Maintenance cost | Production technology |
|-----------|--------------------|------------------|-----------------------|
| 950 | Gas | 2683 | Gas turbine |
| 2000 | Fuel and black oil | 1922.5 | Steam turbine |
| 3500 | Diesel | 5143.4 | Combined cycle |
| | | 316 | Hydropower |

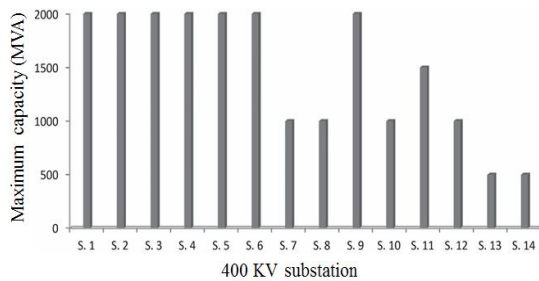

Fig. 7. Capacity of high voltage substation (400 KV)

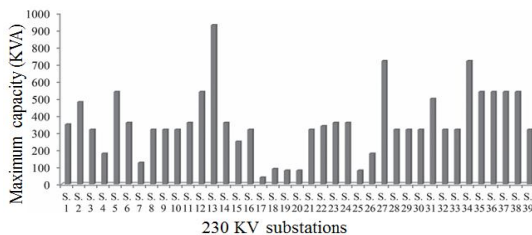

Fig. 8. Capacity of low voltage substation (230 KV)

Tab. 5. Performance evaluation of the proposed Benders decomposition

| Problem | Objective function value | Iteration (Benders) | Time (Benders) | Time (GAMS) | Improve ment (%) |
|------------|--------------------------|---------------------|----------------|-------------|------------------|
| Case study | 1.56913 e+12 | 41 | 935 | 2946 | 68.26 |

Results of quality assessment of the obtained solutions of the stochastic programming in comparison with those of the deterministic model are presented in Table 8. The regarded standard deviation of the capacity of each substation is considered as 10 percent. The 3 numbers of top generated solutions (i.e., ranks 1 to 3) are considered in the solution assessment process. Table 8 shows that the cost of the obtained results from solving the stochastic programming model is significantly less than the average cost of the solutions of the deterministic model. The results indicate that the worst obtained solution of the stochastic programming is much better than the worst obtained solution of the deterministic programming. In addition, under the best condition, there is no significant difference between the performances of these two solution algorithms. Generally, the standard deviation of the solutions to the deterministic model is more than the stochastic programming model.

Tab. 6. Comparison between convergence of the accelerated Benders decomposition (ABD) and the traditional benders decomposition (TBD)

| Algorithm | Iteration to 1% gap | Iteration to 10% gap |
|-----------|---------------------|----------------------|
| TBD | 273 | 185 |
| ABD | 27 | 6 |

Tab. 7. Comparison between total iterations

| | TBD | ABD |
|-------|-----|-----|
| Total | 214 | 41 |

5-2. Case study

Table 9 shows the upper and lower bounds of the objective value in each iteration of the Bender decomposition algorithm. The upper and lower bound limits converge to each other at the 41th iteration. The computational time of the proposed model is 935 seconds. The obtained results of solution algorithm validation indicate the efficiency and capability of the proposed solution algorithm to solve large-scale problems. Details of the proposed plan for power generation and applying preventive maintenance under various scenarios of network facility failure are presented in Table 10. With regard to considering the cost of setting up the power plants in the objective function of the proposed model, the minimum number of required active power plants according to received demands has been considered in the proposed program of the power network management. Although the combined cycle

power plants and gas turbines have higher setup cost, they have more power generation capacity and less requirement for preventive maintenance requirements than other types of power plants.

Therefore, these power plants will have an important contribution to power production in the proposed plan.

Tab. 8. Quality comparison between solutions of the stochastic and deterministic models

| Measures | Deterministic solution | Stochastic solution 1 | Stochastic solution 2 | Stochastic solution 3 |
|---------------------------|------------------------|-----------------------|-----------------------|-----------------------|
| Mean | 18.3585 | 15.6914 | 15.6913 | 15.6917 |
| Maximum | 26.069 | 19.9783 | 15.5535 | 12.0934 |
| Minimum | 9.06287 | 9.21816 | 9.32997 | 9.32828 |
| Range | 17.0061 | 10.7602 | 6.2235 | 2.711113 |
| Standard deviation | 7.83262 | 3.16546 | 1.59346 | 0.0725488 |
| Gap | 11.39 | 1.68 | 1.05 | 0.97 |
| Standard deviation of gap | 1.17 | 0.18 | 0.11 | 0.08 |

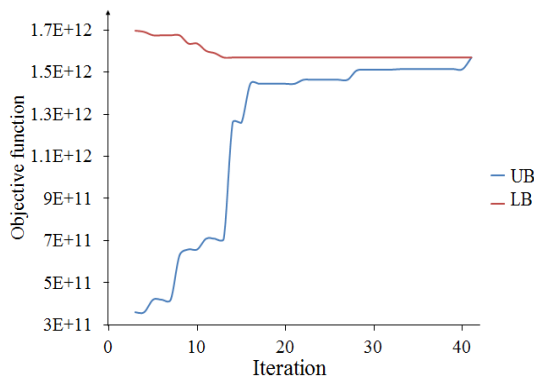

Fig. 9. Upper and lower bounds' convergence

6. Conclusion

In this paper, a two-stage stochastic mixed-integer programming model is proposed for multi-period power network design under uncertainty of capacities of network facilities. The aim of the proposed model is to minimize the total costs of power production and distribution simultaneously via determining an appropriate power generation, power plant establishment, and preventive maintenance plan. In addition, at the operational level, the power flow management between network facilities is conducted. With

respect to considering the case study of the Tehran Regional Electric Company, the proposed model is adaptable to the decision-making environment of Iran power nationwide network. Due to the nature of the network design problem with high complexity, an appropriate solution algorithm based on the accelerated Benders decomposition algorithm is proposed for solving the proposed model. The number of scenarios is reduced via using a k-means clustering method. The obtained results of extensive computational experiments indicate the superiority of the proposed solution algorithm in terms of solution quality and computational time. In addition, the obtained results show the higher robustness of solutions of stochastic programming compared to the deterministic model. For future research, taking into account the strategies and policies of power network management before and after the disruption occurrence due to the critical importance of network service stability under different conditions is suggested. In addition, applying the modified Benders' decomposition method and hybrid metaheuristic solution algorithm for solving large-scale problems may be investigated in future.

Tab. 9. Limits of the proposed Benders decomposition algorithm

| UB | LB | Iteration | UB | LB | Iteration |
|---------|---------|-----------|---------|---------|-----------|
| 15.6913 | 14.6361 | 21 | 18.6335 | 0 | 1 |
| 15.6913 | 14.6361 | 22 | 17.5005 | 2.00535 | 2 |
| 15.6913 | 14.6361 | 23 | 16.9655 | 3.60744 | 3 |

| | | | | | |
|---------|---------|----|---------|---------|----|
| 15.6913 | 14.6361 | 24 | 16.9074 | 3.60744 | 4 |
| 15.6913 | 14.6361 | 25 | 16.7458 | 4.20292 | 5 |
| 15.6913 | 14.6361 | 26 | 16.7458 | 4.20292 | 6 |
| 15.6913 | 15.0684 | 27 | 16.7458 | 4.20292 | 7 |
| 15.6913 | 15.1162 | 28 | 16.7458 | 6.31105 | 8 |
| 15.6913 | 15.1162 | 29 | 16.3551 | 6.58801 | 9 |
| 15.6913 | 15.1162 | 30 | 16.3551 | 6.58801 | 10 |
| 15.6913 | 15.1162 | 31 | 16.0067 | 7.09405 | 11 |
| 15.6913 | 15.1421 | 32 | 15.8969 | 7.09405 | 12 |
| 15.6913 | 15.1421 | 33 | 15.6913 | 7.09405 | 13 |
| 15.6913 | 15.1421 | 34 | 15.6913 | 12.6017 | 14 |
| 15.6913 | 15.1421 | 35 | 15.6913 | 12.6017 | 15 |
| 15.6913 | 15.1421 | 36 | 15.6913 | 14.4462 | 16 |
| 15.6913 | 15.1421 | 37 | 15.6913 | 14.4462 | 17 |
| 15.6913 | 15.1421 | 38 | 15.6913 | 14.4462 | 18 |
| 15.6913 | 15.1421 | 39 | 15.6913 | 14.4462 | 19 |
| 15.6913 | 15.6913 | 40 | 15.6913 | 14.4462 | 20 |
| - | - | 41 | 15.6913 | 14.4462 | 21 |

Parameters. *Engineering Optimization*, Vol. 38, (2006), pp. 647–669.

References

- [1] Zio, E. and T. Aven, Uncertainties in Smart Grids Behavior and Modeling: What are the Risks and Vulnerabilities? How to Analyze Them? *Energy Policy*, Vol. 39, (2011), pp. 6308–6320.
- [2] Wang, J.-W. and L.-L. Rong, Robustness of the Western United States Power Grid Under Edge Attack Strategies Due to Cascading Failures. *Safety Science*, Vol. 49, (2011), pp. 807–812.
- [3] You, A.D., et al., A Study of Electrical Security Risk Assessment System Based on Electricity Regulation. *Energy Policy*, Vol. 39, (2011), pp. 2062-2074.
- [4] ERGEG, Final Report: The Lessons to be Learned from the Large Disturbance in the European Power System on the 4th of November 2006. E06-BAG-01-06. 2007, Brussels.
- [5] UCTE, Final Report: System Disturbance on 4 November 2006, Brussels. (2007).
- [6] van der Vleuten, E. and V. Lagendijk, Transnational Infrastructure Vulnerability: The Historical Shaping of the 2006 European ‘Blackout’. *Energy Policy*, Vol. 38, (2010), pp. 2042–2052.
- [7] Chen, S.-P. and P.-C. Chang, A Mathematical Programming Approach to Supply Chain Models with Fuzzy Parameters. *Engineering Optimization*, Vol. 38, (2006), pp. 647–669.
- [8] Bao, Z.J., et al., Analysis of Cascading Failure in Electric Grid Based on Power Flow Entropy. *Physics Letters*, 2009. A373: 3032–3040.
- [9] Arianos, S., et al., Power Grid Vulnerability: A Complex Network Approach. *Chaos*, Vol. 19, (2009), pp. 0131191–0131196.
- [10] Albert, R., I. Albert, and G.L. Nakarado, Structural Vulnerability of the North American Power Grid. *Physical Review*, (2004), E69: 0251031–0251034.
- [11] Lin, Y.-K., P.-C. Chang, and L. Fiondella, A Study of Correlated Failures on the Network Reliability of Power Transmission Systems. *International Journal of Electrical Power and Energy Systems*, Vol. 43, (2012), pp. 954–960.
- [12] Sun, H.J., H. Zhao, and J.J. Wu, A Robust Matching Model of Capacity to Defense Cascading Failure on Complex Networks. *Physica A: Statistical Mechanics and its Applications*, Vol. 387, (2008), pp. 6431–6435.
- [13] Dueñas-Osorio, L. and S.M. Vemuru, Cascading Failures in Complex Infrastructure Systems. *Structural Safety*, Vol. 31, (2009), pp. 157–167.

- [14] Shahidehpour, M., H. Yamin, and Z. Li, *Market Operations in Electric Power Systems: Forecasting, Scheduling, and Risk Management*. 2002, Hoboken, NJ: Wiley-IEEE Press.
- [15] Xing, W. and F.F. Wu, Genetic Algorithm Based Unit Commitment with Energy Contracts. *International Journal of Electrical Power and Energy Systems*, Vol. 24, (2002), pp. 329–336.
- [16] Billinton, R. and A. Abdulwhab, Short-term Generating Unit Maintenance Scheduling in a Deregulated Power System Using a Probabilistic Approach. *Generation, Transmission and Distribution, IEE Proceedings (150)*, (2003), pp. 463-468.
- [17] Conejo, A.J., R. Garcia-Bertrand, and M. Diaz-Salazar, Generation Maintenance Scheduling in Restructured Power Systems. *IEEE Transactions on Power Systems*, Vol. 20, (2005), pp. 984–992.
- [18] Khosrojerdi, A., et al., A Method For Designing Power Supply Chain Networks Accounting For Failure Scenarios And Preventive Maintenance. *Engineering Optimization*, (2015).
- [19] Hasani, A., S.H. Zegordi, and E. Nikbakhsh, Robust Closed-Loop Global Supply Chain Network Design Under Uncertainty: The Case of The Medical Device Industry. *International Journal of Production Research*, Vol. 53, No.5, (2015), pp. 1596-1624.
- [20] Zegordi, S.H. and A. Hasani, A Robust Competitive Global Supply Chain Network Design under Disruption: The Case of Medical Device Industry. *International Journal of Industrial Engineering and Production Research*, (2015), In press.
- [21] Eskandarpour, M., et al., A Reverse Logistics Network For Recovery Systems and A Robust Metaheuristic Solution Approach. *Int J Adv Manuf Technol*, Vol. 74, (2014), pp. 1393–1406.
- [22] Birge, J.R. and F. Louveaux, *Introduction to Stochastic Programming*. New York: Springer (1997).
- [23] Ruszczyński, A. and A. Shapiro, Stochastic programming models. In: Ruszczyński, A., Shapiro, A. (Eds.), *Stochastic Programming, Handbooks in OR & MS*. Vol. 10, (2003), Elsevier Science.
- [24] Eskandarpour, M., E. Nikbakhsh, and S.H. Zegordi, Variable Neighborhood Search For The Bi-Objective Post-Sales Network Design Problem: A Fitness Landscape Analysis Approach. *Computers & Operations Research*, (2014).
- [25] Hartigan, J.A., *Clustering Algorithms*. New York: John Wiley & Sons (1975).
- [26] Hasani-Marzooni, M. and S.H. Hosseini, Dynamic Analysis of Various Investment Incentives and Regional Capacity Assignment in Iranian Electricity Market. *Energy Policy*, Vol. 56, (2013), pp 271–284.

Follow This Article at The Following Site

Hasani A. Two-stage Stochastic Programing Based on the Accelerated Benders Decomposition for Designing Power Network Design under Uncertainty. *IJIEPR*. 2017; 28 (2) :163-174 URL: <http://ijiepr.iust.ac.ir/article-1-768-en.html>
DOI: 10.22068/ijiepr.28.2.163

